



**71345
LED Floodlight**



Model :		71345
OVERALL LAMP PARAMETERS	Input Voltage	100-277VAC 50/60HZ
	Input Current	0.38A Max
	Input Power	49 W
	Power Factor	PF≥0.90
	Luminance	4357 LM
	Luminous Efficiency	88 LM/W
	CRI	83
	Beam Angle	120°
	Main Structure	Aluminium + Tempered Glass
LED DRIVER	Output Voltage	23-42VDC
	Output Current	1.2A
	Driver Efficiency	89%
LED	LED Manufacturer	cree
	LED Type	CXA1512
	LED Quantity	3 PCS
	LED Efficacy	110 LM/W
	Color Temperature	WW/NW/CW (5050 K)
Photocell	-	Sold Separately
LIFESPAN & ENVIRONMENT	Lifespan	50000Hrs.
	Warranty	5 Years
	IP Rating	IP65 Wet Locations
	Operating Temperature	-40 - +131F
	Storage Temperature.Humidity	-40F - +176F , 10—90% RH
SAFETY&EMC	Safety Norms	UL1598,UL8750, EN60598, EN61347-2-13, EN62031, EN62471
	Withstand Voltage	I/P-FG: 2121VDC
	Grounding Resistance	≤0.5Ω,OK
	Electromagnetic Compatibility	EN55015, EN61000-2-3, EN61000-3-3, EN61547
OTHERS	Dimension	Pls refer to attached dimension drawing
	Net Weight	7.81 lbs
	Packing Size	inner box: L273*W240*H165mm master carton: L549*W485*H175mm
	Q'ty / Carton	4PCS
	Volume	1.65Cbm/carton

Dimension : 71345

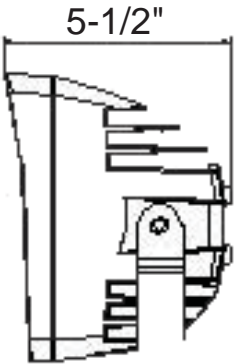
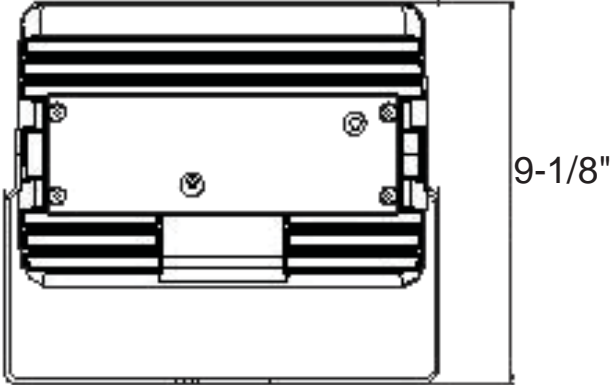
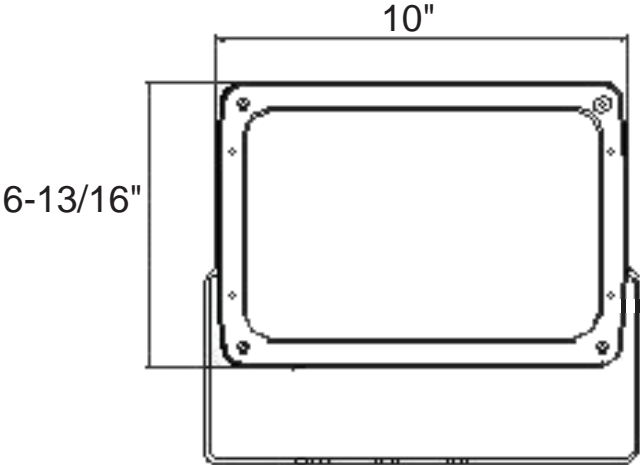



Report No.: GZE140709-L

LM-79-08 Test Report

For

Morris Products Inc
53 Carey Rd
Queensbury, NY 12804

Architectural Flood and Spot Luminaires

Model name(s): 71345, 71346

Representative (Tested) Model: 71345

Model Difference: All construction and rating are the same, except CCT

Test & Report By:

Sean Zhuo

Engineer: Sean Zhuo

Date: Jul.29,2014

Review By:

Tommy Liang

Manager: Tommy Liang

Note: This report does not imply product certification, approval, or endorsement by NVLAP, NIST, or any agency of the Federal Government.

Laboratory: Standard-Tech Co. Ltd Testing Center
NVLAP CODE: 201011-0

Report Format Number STD/QR4909-A/2

Address: 8th floor, Block B, No. 11 Caipin Road, Guangzhou Science City, Tianhe, Guangzhou 510663, China

Tel: 8620-3229 0320 Fax: 8620-32290422 <http://www.standard-tech.com>

U.S. Department of Energy

Lighting Facts™ Uniform LM-79 Reporting Template

Laboratory Information:

Name of Test Laboratory	Standard-Tech Co. Ltd
Date of Test Report	Jul.29,2014
Test Report No.	GZE140709-L
Laboratory Contact Name	Tommy Liang

Product Information:

Organization Name	Morris Products	
Brand Name	MORRIS	
Model Number	71345	
SKU (if available)	N/A	
Type of Luminaire (for integral lamps, list base type and lamp type)	Architectural Flood and Spot Luminaires	
Luminaire Aperture (for downlights)	--	in.
Luminaire Length	--	mm
Luminaires Width	--	mm
Number of Units (modular products)	N/A	s

	Integrating Sphere Output	Goniophotometer Output	
Electrical Measurements:			
Input Wattage	49.44	--	W
Input Current	0.4177	--	A
Input Voltage (ac)	120.0	--	V
Power Factor	0.9863	--	
Off-State Power	0	--	W

Photometric Characteristics

Total Initial Lumen Output	4357.9	--	lm
Initial Lumen Efficacy	88.14	--	lm/w
Correlated color temperature / CCT	5050	--	K
Color rendering index / CRI	83.2	--	
R9 Value	13	--	
Duv	0.0030	--	
Luminous Intensity Distribution			
Center beam candlepower (if applicable)	-----	--	
Beam angle (if applicable)		--	
Zonal lumens in the 0°-60° zone		--	
Zonal lumens in the 60°-90° zone		--	
Zonal lumens in the 90°-120° zone		--	
Zonal lumens in the 120°-180° zone		--	

Laboratory: Standard-Tech Co. Ltd Testing Center
NVLAP CODE: 201011-0

Report Format Number STD/QR4909-A/2

Address: 8th floor, Block B, No. 11 Caipin Road, Guangzhou Science City, Tianhe, Guangzhou 510663, China

Tel: 8620-3229 0320 Fax: 8620-32290422 <http://www.standard-tech.com>

Test Specifications:	
Date of Receipt	: Jul.28,2014
Date of Test	: Jul.29,2014
Test item	: Total Luminous Flux, Luminous Distribution Intensity, Luminous Efficacy, Correlated Color Temperature, Color Rendering Index, Chromaticity Coordinate, Electrical parameters
Reference Standard	IES LM-79-2008 Electrical and Photometric Measurements of Solid-State Lighting Products ANSI C78.377-2008 Specifications for the Chromaticity of Solid State Lighting Products CIE 13.3-1995 Method of Measuring and Specifying Colour Rendering Properties of Light Sources CIE 15-2004 Technical Report Colorimetry IESNA LM-16-93 Practical Guide to Colorimetry of Light Source IESNA TM-16-05 Technical Memorandum on Light Emitting Diode (LED) Sources and Systems
Reference Work Instruction	QD25

Test Methods

1. Photometric and Electrical measurements – Light Distribution Method:

Photometric parameters were measured using the goniophotometer and software. The ambient temperature shall be maintained at $25^{\circ}\text{C} \pm 1^{\circ}\text{C}$, measured at a point not more than 1 m from the sample and at the same height as the sample. The sample was operated at 120 Volts AC, 60Hz. It was stabilized before measurement was made. Luminous flux, luminaire efficacy, zonal lumen were calculated from the software taken at 1° vertical intervals and 22.5° horizontal intervals.

2. Photometric and Electrical Measurements – Integrating Sphere Method:

Photometric parameters were measured using an integrating sphere, a spectroradiometer and software. The ambient temperature condition inside the sphere was maintained at $25^{\circ}\text{C} \pm 1^{\circ}\text{C}$. The sample measurements were made using a spectroradiometer connected by a fiber optic cable and detector through the detector port of the integrating sphere. The sample was operated at 120 Volts AC, 60Hz. It was stabilized before measurement was made. Chromaticity coordinates, correlated color temperature and color rendering index were calculated from the spectral radiant flux measurements taken at least 5 nm intervals over the range of 380 to 780 nm.

1. Product Information:

Brand Name	MORRIS
Model Number	71345
Luminaire Type	Architectural Flood and Spot Luminaires
Rated Voltage / Frequency	100 ~ 277 Vac, 50/60 Hz
Nominal Power	50W
Rated Initial Lamp Lumen	--
Declared CCT	3000K,3500K,4000K,4500K,5000K
LED Manufacturer	CREE
LED Model	CXA1512
Sample Receipt Date	Jul.28,2014
Sample Number	140709-31(3000K),32 (5000K)

Photo



**Laboratory: Standard-Tech Co. Ltd Testing Center
NVLAP CODE: 201011-0**

Report Format Number STD/QR4909-A/2

Address: 8th floor, Block B, No. 11 Caipin Road, Guangzhou Science City, Tianhe, Guangzhou 510663, China

Tel: 8620-3229 0320 Fax: 8620-32290422 <http://www.standard-tech.com>

2.1 Electrical, Photometric and Chromaticity Measurements (Refer to Work Instruction QD25)	IES LM-79 2008
------------------------------------------------------------------------------------------------------	-----------------------

Test date	2014-07-29	Test Ambient:	25.2 °C
Test Orientation	Lighting Downward, light surface parallel to horizontal line	Stabilization Time (min)	90
Model Number	71345		

Electrical Measurement:

Sample No.	Voltage (Vac)	Frequency (Hz)	Current (A)	Power (W)	Power Factor	THD %
140709-31	120.0	60	0.4224	49.84	0.9824	15.63
	277.0	60	0.2012	50.72	0.9100	18.66

Sphere-Spectroradiometer Method:

Parameter	Result
Test Voltage (V)	120.0
Frequency (Hz)	60
Color Rendering Index (CRI)	82.7
R9	11
CCT (K)	3151
Chromaticity (x, y)	x=0.4293 y=0.4064
Chromaticity (u', v')	u'=0.2447 v'=0.5212
Duv	0.0021

Special Color Rendering Indices			
R1	81	R9	11
R2	88	R10	73
R3	95	R11	82
R4	82	R12	68
R5	81	R13	82
R6	85	R14	97
R7	86	R15	74
R8	63	--	--

Goniophotometer Method:

Parameter	Result
Test Voltage (V)	120.0
Frequency (Hz)	60
Total Luminous (lm)	3781.3
Luminous Efficacy (lm/W)	75.87
Beam Angle°	106.6
Center Beam Candle Power (cd)	1731
S/MH(C0/180)	1.24
S/MH(C90/270)	1.19

Spectral Power Distribution

Spectral Power Distribution:

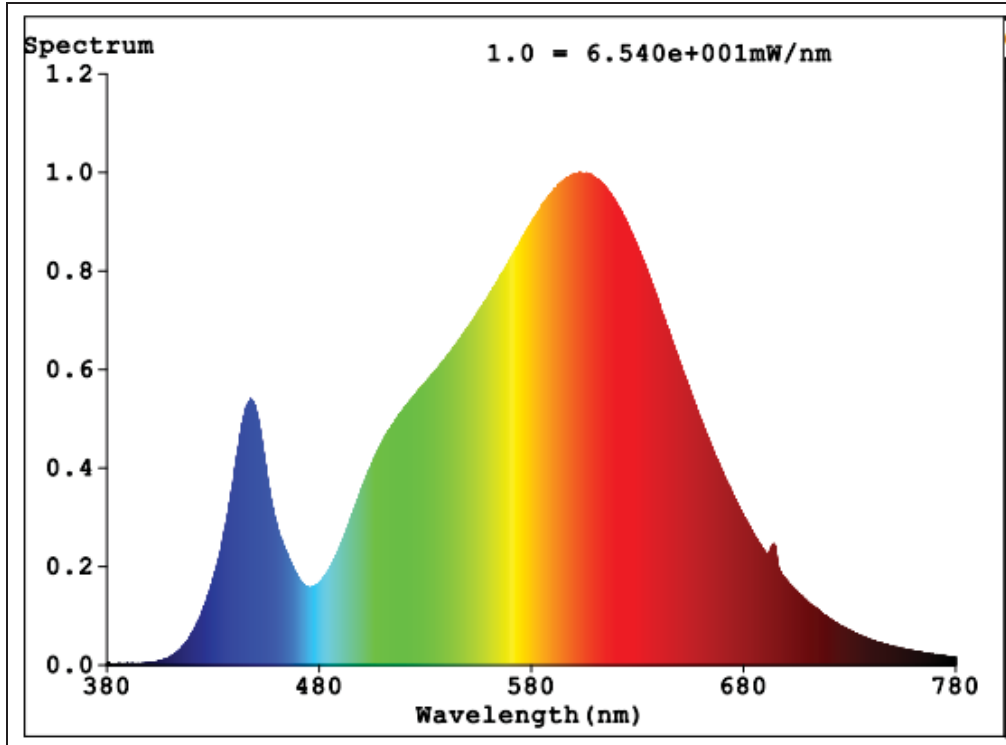

Laboratory: Standard-Tech Co. Ltd Testing Center
NVLAP CODE: 201011-0

Report Format Number STD/QR4909-A/2

Address: 8th floor, Block B, No. 11 Caipin Road, Guangzhou Science City, Tianhe, Guangzhou 510663, China

Tel: 8620-3229 0320 Fax: 8620-32290422 <http://www.standard-tech.com>

Chromaticity Diagram

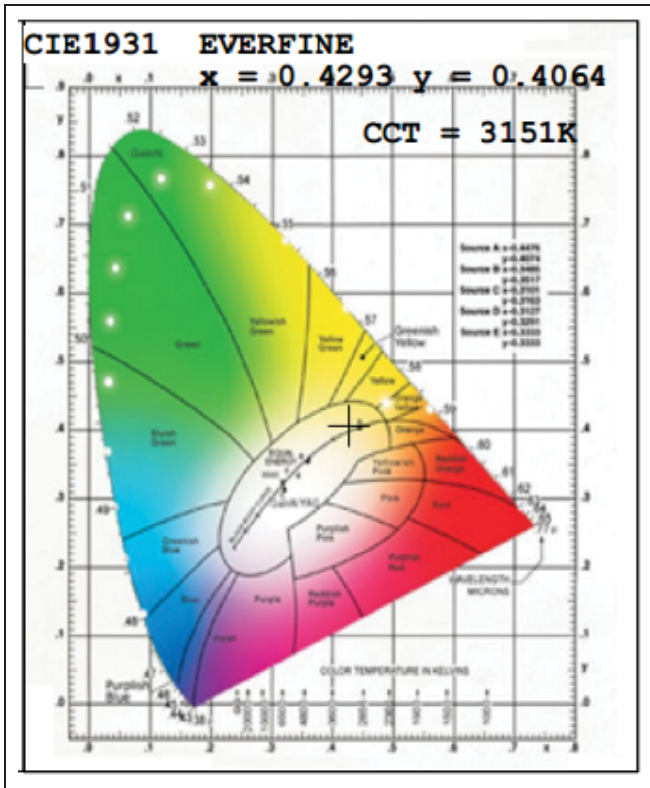

Laboratory: Standard-Tech Co. Ltd Testing Center
NVLAP CODE: 201011-0

Report Format Number STD/QR4909-A/2

Address: 8th floor, Block B, No. 11 Caipin Road, Guangzhou Science City, Tianhe, Guangzhou 510663, China

Tel: 8620-3229 0320 Fax: 8620-32290422 <http://www.standard-tech.com>

Zonal Lumen Tabulation

Zonal Lumen Summary			
Zone	Lumens	% Lamp	% Luminaire
0-30	1,293.8	34.2%	34.2%
0-40	2,102.1	55.6%	55.6%
0-60	3,563.7	94.2%	94.3%
60-90	208.5	5.5%	5.5%
70-100	22.9	0.6%	0.6%
90-120	1.0	0%	0%
0-90	3,772.2	99.8%	99.8%
90-180	8.3	0.2%	0.2%
0-180	3,780.5	100%	100%

Lumens Per Zone					
Zone	Lumens	% Total	Zone	Lumens	% Total
0-10	159.5	4.2%	90-100	0.0	0%
10-20	454.9	12.0%	100-110	0.3	0%
20-30	679.3	18.0%	110-120	0.8	0%
30-40	808.4	21.4%	120-130	1.3	0%
40-50	841.9	22.3%	130-140	1.7	0%
50-60	619.6	16.4%	140-150	1.6	0%
60-70	185.6	4.9%	150-160	1.4	0%
70-80	20.8	0.5%	160-170	0.9	0%
80-90	2.1	0.1%	170-180	0.4	0%

Laboratory: Standard-Tech Co. Ltd Testing Center
NVLAP CODE: 201011-0

Report Format Number STD/QR4909-A/2

Address: 8th floor, Block B, No. 11 Caipin Road, Guangzhou Science City, Tianhe, Guangzhou 510663, China

Tel: 8620-3229 0320 Fax: 8620-32290422 <http://www.standard-tech.com>

Photometric Data

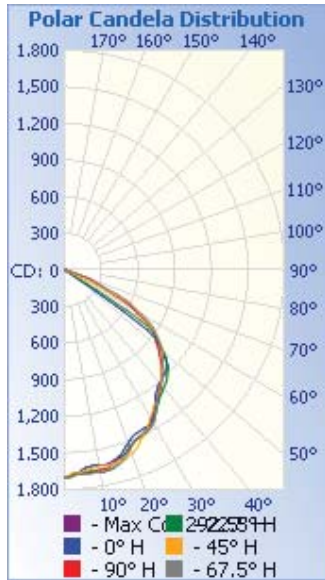

Flood Summary

	Efficiency	Lumens	Horizontal Spread	Vertical Spread
Field (10%):	98.4%	3,721.3	139	111.7
Beam (50%):	85.1%	3,217.3	109.9	102.6
Total:	100%	3,779.8		

Illuminance Plots

	Illuminance at a Distance	
	Center Beam fc	Beam Width
17.0ft	5.91 fc	42.4 ft 48.5 ft
34.0ft	1.48 fc	84.9 ft 96.9 ft
51.0ft	0.66 fc	127.3 ft 145.4 ft
68.0ft	0.37 fc	169.7 ft 193.9 ft
85.0ft	0.24 fc	212.2 ft 242.4 ft
102.0ft	0.16 fc	254.6 ft 290.8 ft

■ Vert. Spread: 102.6°
■ Horiz. Spread: 109.9°

ISOCANDELA DIAGRAM

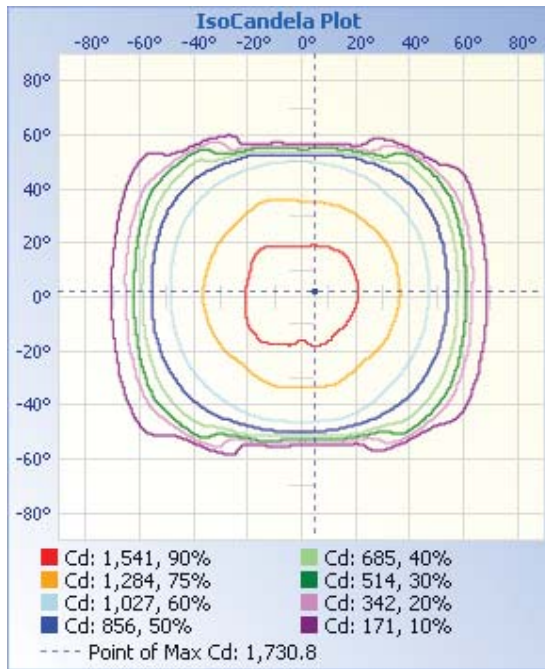

ISOLUX DIAGRAM

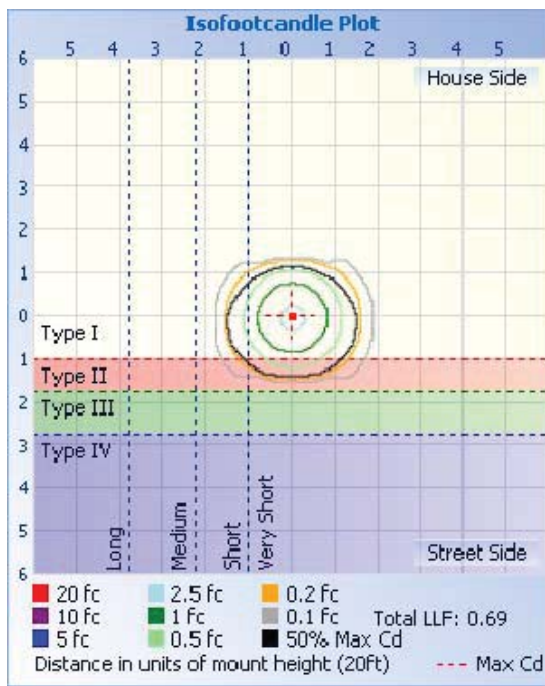

Laboratory: Standard-Tech Co. Ltd Testing Center
NVLAP CODE: 201011-0

Report Format Number STD/QR4909-A/2

Address: 8th floor, Block B, No. 11 Caipin Road, Guangzhou Science City, Tianhe, Guangzhou 510663, China

Tel: 8620-3229 0320 Fax: 8620-32290422 <http://www.standard-tech.com>

Candela Table - Type C

	0	22.5	45	67.5	90	112.5	135	157.5	180	202.5	225	247.5	270	292.5	315	337.5	360
0	1708	1708	1708	1708	1708	1708	1708	1708	1708	1708	1708	1708	1708	1708	1708	1708	1708
1	1700	1703	1692	1706	1703	1702	1700	1700	1724	1717	1694	1705	1695	1722	1709	1714	1700
2	1684	1691	1675	1703	1699	1692	1705	1690	1708	1712	1691	1716	1698	1730	1713	1704	1684
3	1670	1682	1674	1689	1686	1692	1701	1687	1693	1704	1693	1705	1702	1731	1707	1695	1670
4	1669	1672	1672	1686	1678	1684	1698	1674	1681	1702	1682	1692	1707	1726	1710	1687	1669
5	1650	1671	1666	1685	1680	1690	1702	1671	1670	1685	1669	1685	1697	1718	1707	1677	1650
6	1635	1673	1660	1686	1671	1697	1698	1658	1645	1677	1659	1690	1686	1713	1696	1670	1635
7	1633	1668	1654	1690	1678	1694	1694	1651	1626	1666	1657	1680	1688	1701	1685	1660	1633
8	1624	1672	1646	1686	1682	1698	1682	1644	1602	1648	1644	1665	1670	1690	1687	1654	1624
9	1625	1679	1640	1684	1667	1695	1673	1648	1589	1653	1635	1657	1655	1676	1672	1651	1625
10	1628	1683	1634	1685	1668	1690	1665	1653	1573	1643	1625	1651	1647	1664	1652	1649	1628
11	1634	1693	1637	1690	1668	1687	1650	1652	1578	1637	1622	1642	1639	1651	1646	1652	1634
12	1637	1686	1642	1682	1667	1672	1637	1647	1573	1631	1605	1628	1632	1645	1624	1656	1637
13	1634	1682	1652	1686	1662	1654	1626	1634	1570	1627	1601	1631	1631	1643	1616	1650	1634
14	1619	1677	1643	1675	1643	1640	1623	1622	1570	1621	1575	1629	1623	1632	1617	1647	1619
15	1612	1658	1643	1666	1624	1620	1606	1607	1566	1616	1566	1611	1624	1625	1603	1640	1612
16	1597	1631	1636	1658	1611	1602	1598	1586	1523	1599	1555	1602	1614	1615	1596	1634	1597
17	1587	1612	1637	1641	1604	1590	1597	1562	1521	1583	1550	1585	1592	1603	1584	1624	1587
18	1561	1592	1633	1617	1594	1574	1580	1556	1515	1559	1541	1562	1576	1594	1588	1607	1561
19	1537	1567	1619	1591	1592	1563	1579	1528	1497	1535	1519	1541	1561	1580	1578	1579	1537
20	1521	1549	1607	1569	1557	1555	1568	1505	1488	1512	1511	1517	1553	1566	1575	1552	1521
21	1498	1538	1599	1546	1539	1549	1555	1499	1481	1500	1501	1504	1535	1546	1563	1531	1498
22	1482	1518	1578	1525	1530	1545	1552	1483	1471	1477	1497	1481	1513	1526	1545	1518	1482
23	1470	1516	1564	1511	1514	1541	1518	1475	1469	1458	1485	1478	1503	1508	1537	1491	1470
24	1466	1508	1529	1501	1505	1530	1494	1460	1453	1445	1480	1470	1493	1487	1513	1473	1466
25	1462	1501	1519	1493	1503	1511	1467	1452	1446	1428	1457	1459	1477	1461	1495	1465	1462
26	1457	1502	1490	1486	1486	1496	1439	1436	1429	1416	1439	1452	1458	1446	1479	1449	1457
27	1456	1489	1474	1480	1475	1469	1402	1419	1423	1400	1413	1444	1444	1437	1458	1444	1456
28	1453	1485	1454	1478	1463	1442	1369	1398	1406	1388	1378	1434	1424	1417	1436	1421	1453
29	1446	1472	1433	1471	1445	1417	1358	1377	1380	1377	1353	1411	1396	1404	1419	1421	1446

Laboratory: Standard-Tech Co. Ltd Testing Center
NVLAP CODE: 201011-0

Report Format Number STD/QR4909-A/2

Address: 8th floor, Block B, No. 11 Caipin Road, Guangzhou Science City, Tianhe, Guangzhou 510663, China

Tel: 8620-3229 0320 Fax: 8620-32290422 <http://www.standard-tech.com>

30	1430	1454	1405	1458	1423	1385	1338	1355	1356	1358	1327	1389	1378	1395	1407	1413	1430
31	1407	1430	1393	1436	1399	1364	1319	1337	1330	1335	1298	1361	1371	1382	1380	1396	1407
32	1385	1407	1364	1405	1376	1340	1300	1316	1304	1320	1276	1338	1345	1367	1365	1381	1385
33	1357	1382	1343	1376	1355	1317	1276	1302	1285	1297	1263	1312	1329	1356	1341	1364	1357
34	1333	1356	1329	1345	1328	1300	1260	1285	1269	1279	1248	1284	1322	1338	1314	1336	1333
35	1300	1338	1316	1323	1316	1285	1250	1261	1255	1266	1230	1264	1304	1321	1311	1314	1300
36	1272	1318	1293	1291	1305	1268	1230	1244	1239	1257	1214	1239	1288	1291	1288	1291	1272
37	1254	1300	1272	1273	1291	1255	1212	1226	1219	1242	1192	1223	1270	1282	1260	1266	1254
38	1241	1290	1259	1256	1268	1230	1198	1208	1198	1225	1171	1196	1239	1253	1245	1264	1241
39	1223	1281	1239	1235	1254	1210	1184	1188	1179	1202	1151	1172	1209	1230	1216	1242	1223
40	1213	1263	1223	1227	1230	1189	1166	1168	1159	1187	1134	1147	1179	1206	1191	1229	1213
41	1209	1254	1203	1215	1209	1165	1151	1140	1135	1168	1111	1123	1150	1176	1172	1209	1209
42	1193	1243	1185	1197	1184	1148	1136	1124	1119	1146	1081	1099	1132	1157	1150	1197	1193
43	1189	1231	1165	1181	1161	1132	1109	1108	1107	1113	1056	1074	1109	1139	1123	1183	1189
44	1182	1213	1144	1168	1141	1113	1082	1086	1097	1092	1038	1048	1082	1118	1100	1155	1182
45	1177	1193	1129	1151	1128	1090	1064	1060	1072	1063	1019	1028	1065	1096	1080	1139	1177
46	1175	1176	1116	1125	1104	1081	1040	1038	1037	1037	999	1009	1048	1079	1065	1122	1175
47	1153	1154	1100	1100	1076	1045	1013	1014	983	1007	984	990	1026	1046	1044	1095	1153
48	1127	1121	1084	1083	1051	1026	988	981	909	970	952	969	1002	1025	1025	1074	1127
49	1101	1093	1063	1060	1028	995	949	932	866	909	912	950	977	1002	1007	1056	1101
50	1054	1060	1050	1037	1005	965	920	870	838	842	879	928	955	977	988	1020	1054
51	1016	1034	1029	1018	979	946	886	820	789	806	851	897	935	952	963	985	1016
52	977	989	1001	994	953	914	863	791	610	775	826	865	910	932	949	943	977
53	943	942	973	970	929	884	840	760	323	731	792	836	880	908	926	903	943
54	841	920	946	944	915	859	816	665	86	560	767	800	852	879	894	878	841
55	570	880	909	913	898	843	791	419	38	282	729	768	826	859	869	846	570
56	235	817	872	888	868	820	751	153	39	67	693	741	761	830	829	755	235
57	57	618	836	864	821	785	697	37	46	34	649	701	702	801	795	481	57
58	41	303	799	828	756	738	638	31	46	35	601	650	657	759	759	172	41
59	36	70	754	781	696	688	602	36	23	38	564	605	621	705	715	40	36
60	32	37	710	731	657	634	571	39	20	32	510	566	569	646	674	32	32
61	29	38	669	670	624	598	527	27	17	20	341	520	466	607	637	31	29

Laboratory: Standard-Tech Co. Ltd Testing Center
 NVLAP CODE: 201011-0

Report Format Number STD/QR4909-A/2

Address: 8th floor, Block B, No. 11 Caipin Road, Guangzhou Science City, Tianhe, Guangzhou 510663, China

Tel: 8620-3229 0320 Fax: 8620-32290422 <http://www.standard-tech.com>

62	26	34	636	632	570	562	353	18	15	17	113	431	365	568	589	25	26
63	22	26	593	596	470	522	124	16	14	15	21	317	323	496	439	22	22
64	19	22	413	555	386	421	26	14	12	13	17	268	294	385	169	20	19
65	17	20	147	484	354	331	21	12	11	12	15	244	263	301	28	17	17
66	15	17	27	378	332	304	18	11	10	10	13	218	236	268	18	15	15
67	14	15	21	321	307	278	15	10	9	9	12	192	214	243	16	14	14
68	13	14	18	297	281	250	13	9	8	9	10	166	189	219	14	12	13
69	12	12	16	273	253	225	11	8	7	8	9	140	133	195	13	11	12
70	11	11	14	249	219	193	10	7	7	7	8	85	66	170	11	10	11
71	10	10	13	226	148	154	8	7	6	6	7	47	53	87	10	10	10
72	9	10	11	180	92	76	7	6	6	6	6	36	44	60	9	9	9
73	9	9	10	98	78	61	6	6	5	5	5	23	35	50	8	8	9
74	8	8	9	82	62	47	5	5	5	5	5	6	9	32	7	8	8
75	8	8	8	68	50	21	5	5	4	4	4	5	5	7	7	7	8
76	7	8	7	12	8	6	4	4	4	4	4	4	4	6	6	7	7
77	7	7	6	6	5	5	4	3	3	3	3	4	4	6	6	7	7
78	7	7	6	6	4	4	3	3	3	3	3	3	3	5	5	6	7
79	7	7	6	5	4	4	3	3	2	2	2	3	3	5	5	6	7
80	6	6	5	5	3	3	2	2	2	2	2	2	3	4	5	6	6
81	5	6	5	5	3	3	2	2	2	2	1	2	2	4	5	5	5
82	5	5	5	4	2	2	1	2	2	1	1	1	2	4	4	4	5
83	4	4	5	4	2	2	1	1	1	1	1	1	2	3	4	4	4
84	4	4	4	3	2	1	1	1	1	1	1	0	1	3	3	4	4
85	4	4	4	3	1	1	1	1	1	1	0	0	1	2	3	3	4
86	4	4	3	3	1	1	1	1	1	1	0	0	0	2	3	3	4
87	3	4	3	2	0	0	1	1	1	1	0	0	0	2	3	3	3
88	2	3	3	2	0	0	0	1	1	1	0	0	0	1	1	2	2
89	0	1	2	2	0	0	0	0	0	0	0	0	0	0	0	0	0
90	0	0	0	0	0	0	0	0	0	0	0	0	0	0	0	0	0

Laboratory: Standard-Tech Co. Ltd Testing Center
 NVLAP CODE: 201011-0

Report Format Number STD/QR4909-A/2

Address: 8th floor, Block B, No. 11 Caipin Road, Guangzhou Science City, Tianhe, Guangzhou 510663, China

Tel: 8620-3229 0320 Fax: 8620-32290422 <http://www.standard-tech.com>

2.2 Electrical, Photometric and Chromaticity Measurements (Refer to Work Instruction QD25)	IES LM-79 2008
------------------------------------------------------------------------------------------------------	-----------------------

Test date	2014-07-29	Test Ambient:	25.2 ° C
Test Orientation	Lighting Downward, light surface parallel to horizontal line	Stabilization Time (min)	90
Model Number	71345		

Electrical Measurement:

Sample No.	Voltage (Vac)	Frequency (Hz)	Current (A)	Power (W)	Power Factor	THD %
140709-32	120.0	60	0.4177	49.44	0.9863	13.22
	277.0	60	0.1995	50.14	0.9074	17.12

Sphere-Spectroradiometer Method:

Parameter	Result	Special Color Rendering Indices			
Test Voltage (V)	120.0	R1	81	R9	13
Frequency (Hz)	60	R2	88	R10	70
Color Rendering Index (CRI)	83.2	R3	92	R11	81
R9	13	R4	83	R12	61
CCT (K)	5050	R5	82	R13	83
Chromaticity (x, y)	x=0.3442 y=0.3570	R6	83	R14	95
Chromaticity (u', v')	u'=0.2088 v'=0.4871	R7	88	R15	77
Duv	0.0030	R8	69	--	--
Total Luminous (lm)	4357.9				
Luminous Efficacy (lm/W)	88.14				

Spectral Power Distribution

Spectral Power Distribution:

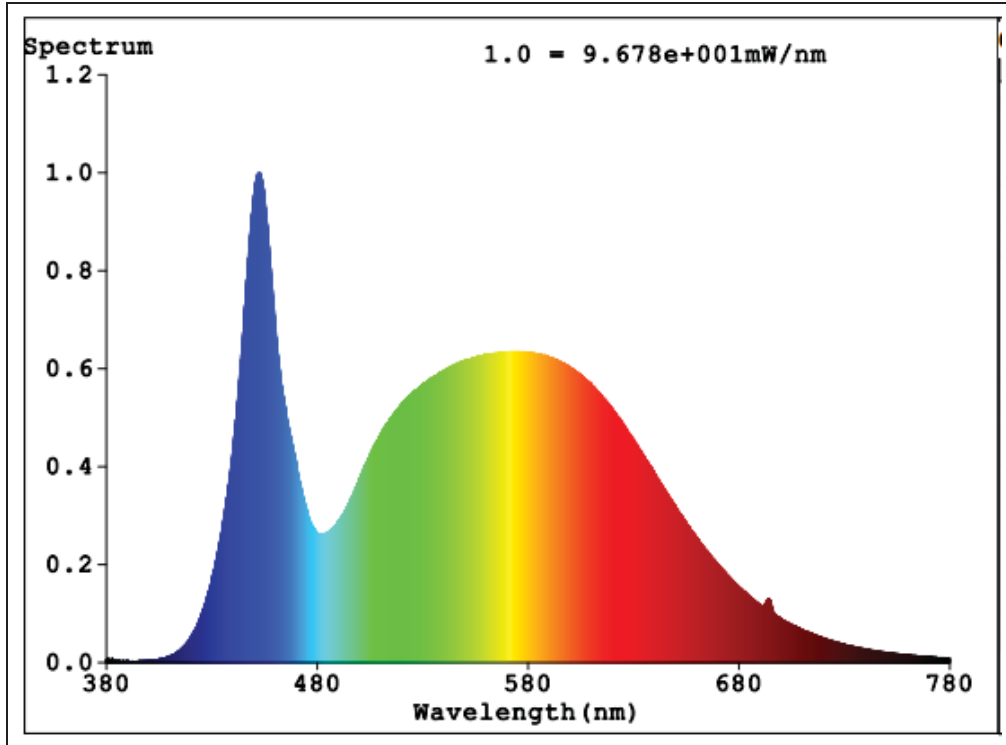

Laboratory: Standard-Tech Co. Ltd Testing Center
NVLAP CODE: 201011-0

Report Format Number STD/QR4909-A/2

Address: 8th floor, Block B, No. 11 Caipin Road, Guangzhou Science City, Tianhe, Guangzhou 510663, China

Tel: 8620-3229 0320 Fax: 8620-32290422 <http://www.standard-tech.com>

Chromaticity Diagram

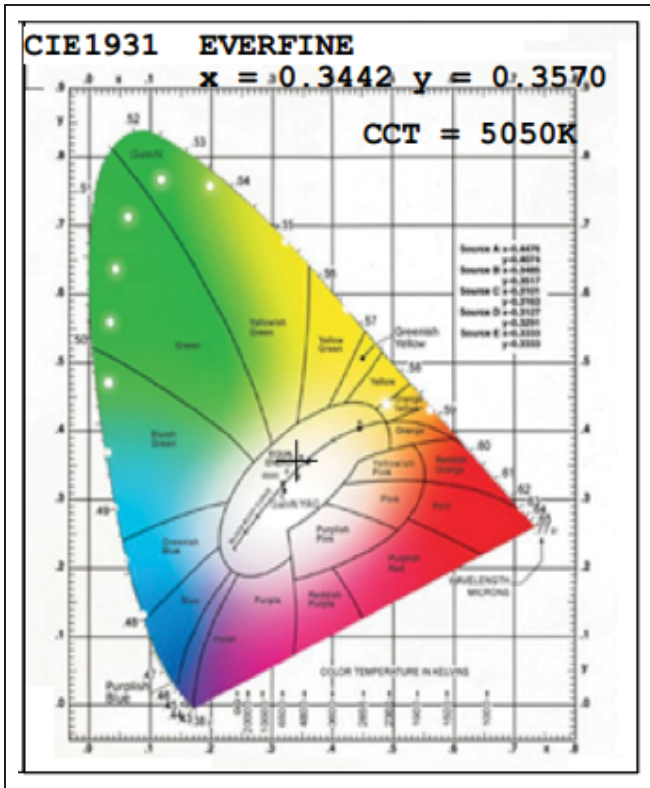

Laboratory: Standard-Tech Co. Ltd Testing Center
 NVLAP CODE: 201011-0

Report Format Number STD/QR4909-A/2

Address: 8th floor, Block B, No. 11 Caipin Road, Guangzhou Science City, Tianhe, Guangzhou 510663, China

Tel: 8620-3229 0320 Fax: 8620-32290422 <http://www.standard-tech.com>

3. Test Equipment

Equipment ID	Equipment Name	Last Calibration Date	Next Calibration Date
ST-R-336	2 meter Integrating Sphere	2014-07-01	2015-06-30
ST-R-331	Spectral analysis system HAAS-2000	2014-07-01	2015-06-30
D204	Standard Lamp	2014-07-01	2015-06-30
PF2010	Power Meter for Integrating Sphere	2014-07-01	2015-06-30
EE-09	Goniophotometer system	2014-07-01	2015-06-30
D908S	Standard Lamp	2014-07-01	2015-06-30
PF210	Power Meter for Goniophotometer	2014-07-01	2015-06-30
ST-R-181A	Temperature Tester	2014-07-01	2015-06-30

******* END OF DATASHEET PACKAGE *******