



Catalog Number 71372
UPC Number 601986713726
Description LED Bullet Flood Light
12W 814 Lumen



Features

- Cree CXA LED's, CRI: 75
- Voltage: 120-277VAC
- Isolated Driver Compartment for Optimal Thermal Management
- Corrosion Resistant Die Cast Aluminum Housing
- Superior Architectural Black Powder Coat Finish
- Fluted Reflector & Tempered Glass Lens
- Waterproof & Durable Silicone Rubber Gaskets
- 1/2" NPT Knuckle Mount
- Power Factor: 95%
- Luminous Efficiency: 73 Lumens/watt
- Light Pattern: 23° Beam Spread Flood
- Operation Temperature: -40F to 131F
- 50,000+ Hour LED Life Expectancy
- IC Current Controlled LED Circuits
- Color Temperature: 5000K Cool White
- DLC (Design Light Consortium) \
- cULus Listed
- 5 Year Warranty

General

Lumen Output: 814
Color Temperature: 5000K Cool White
CRI: 75
Light Pattern: 23° Beam Spread Flood
Operation Temperature: -40F to 131F
Housing: Corrosion Resistant Die Cast Aluminum Housing
Housing Color: Black

Dimension Information

Height: 7-1/2"
Depth: 6-5/8"
Diameter: 4"
Weight: 2 lbs

Specifications

Voltage: 120/208/240/277
Input Current: .15A @ 120V
Power Consumption: 12 Watts

Packaging

Box Qty 1
Master Box Qty 6

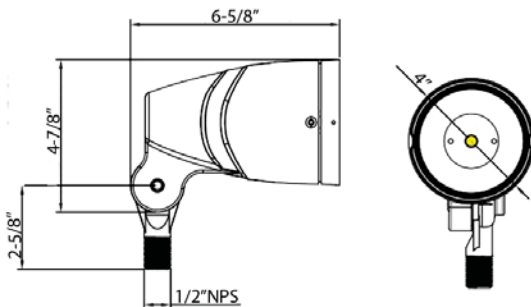



Report No.: GZE140307-E

LM-79-08 Test Report

For

Morris Products Inc. (Brand Name: Morris)

53 Carey Road
Queensbury, NY 12804

Landscape/Accent Flood and Spot Luminaires

Model name(s): 71372

Test & Report By:

Sean Zhuo

Engineer: Sean Zhuo

Date: Apr.04,2014

Review By:

Tommy Liang

Manager: Tommy Liang

Note: This report does not imply product certification, approval, or endorsement by NVLAP, NIST, or any agency of the Federal Government.

Laboratory: Standard-Tech Co. Ltd Testing Center
NVLAP CODE: 201011-0

Report Format Number STD/QR4909-A/2

Address: 8th floor, Block B, No. 11 Caipin Road, Guangzhou Science City, Tianhe, Guangzhou 510663, China

Tel: 8620-3229 0320 Fax: 8620-32290422 <http://www.standard-tech.com>

U.S. Department of Energy

Lighting Facts™ Uniform LM-79 Reporting Template

Laboratory Information:

Name of Test Laboratory	Standard-Tech Co. Ltd
Date of Test Report	Apr.04,2014
Test Report No.	GZE140307-E
Laboratory Contact Name	Tommy Liang

Product Information:

Organization Name	Morris Products Inc.	
Brand Name	Morris	
Model Number	71363	
SKU (if available)	N/A	
Type of Luminaire (for integral lamps, list base type and lamp type)	Landscape/Accent Flood and Spot Luminaires	
Luminaire Aperture (for downlights)	--	in.
Luminaire Length	--	mm
Luminaires Width	--	mm
Number of Units (modular products)	N/A	s

	Integrating Sphere Output	Goniophotometer Output	
Electrical Measurements:			
Input Wattage	--	11.05	W
Input Current	--	0.0950	A
Input Voltage (ac)	--	120.1	V
Power Factor	--	0.9683	
Off-State Power	--	0	W

Photometric Characteristics

Total Initial Lumen Output	--	814.25	lm
Initial Lumen Efficacy	--	73.69	lm/w
Correlated color temperature / CCT	5098	--	K
Color rendering index / CRI	75.1	--	
R9 Value	0	--	
Duv	-0.0003	--	

Luminous Intensity Distribution

Center beam candlepower (if applicable)	-----	672.4	cd
Beam angle (if applicable)		68.5	°
Zonal lumens in the 0°-60° zone		99.5	%
Zonal lumens in the 60°-90° zone		0.5	%
Zonal lumens in the 90°-120° zone		0.0	%
Zonal lumens in the 120°-180° zone		0.0	%

Laboratory: Standard-Tech Co. Ltd Testing Center
NVLAP CODE: 201011-0

Report Format Number STD/QR4909-A/2

Address: 8th floor, Block B, No. 11 Caipin Road, Guangzhou Science City, Tianhe, Guangzhou 510663, China

Tel: 8620-3229 0320 Fax: 8620-32290422 <http://www.standard-tech.com>

Test Specifications:	
Date of Receipt	: Mar.28,2014
Date of Test	:Apr.04,2014
Test item	: Total Luminous Flux, Luminous Distribution Intensity, Luminous Efficacy, Correlated Color Temperature, Color Rendering Index, Chromaticity Coordinate, Electrical parameters
Reference Standard	IES LM-79-2008 Electrical and Photometric Measurements of Solid-State Lighting Products ANSI C78.377-2008 Specifications for the Chromaticity of Solid State Lighting Products CIE 13.3-1995 Method of Measuring and Specifying Colour Rendering Properties of Light Sources CIE 15-2004 Technical Report Colorimetry IESNA LM-16-93 Practical Guide to Colorimetry of Light Source IESNA TM-16-05 Technical Memorandum on Light Emitting Diode (LED) Sources and Systems
Reference Work Instruction	QD25

Test Methods

1. Photometric and Electrical measurements – Light Distribution Method:

Photometric parameters were measured using the goniophotometer and software. The ambient temperature shall be maintained at $25^{\circ}\text{C} \pm 1^{\circ}\text{C}$, measured at a point not more than 1 m from the sample and at the same height as the sample. The sample was operated at 120 Volts AC, 60Hz. It was stabilized before measurement was made. Luminous flux, luminaire efficacy, zonal lumen were calculated from the software taken at 1° vertical intervals and 22.5° horizontal intervals.

2. Photometric and Electrical Measurements – Integrating Sphere Method:

Photometric parameters were measured using an integrating sphere, a spectroradiometer and software. The ambient temperature condition inside the sphere was maintained at $25^{\circ}\text{C} \pm 1^{\circ}\text{C}$. The sample measurements were made using a spectroradiometer connected by a fiber optic cable and detector through the detector port of the integrating sphere. The sample was operated at 120 Volts AC, 60Hz. It was stabilized before measurement was made. Chromaticity coordinates, correlated color temperature and color rendering index were calculated from the spectral radiant flux measurements taken at least 5 nm intervals over the range of 380 to 780 nm.

1. Product Information:

Brand Name	Morris
Model Number	71363
Luminaire Type	Landscape/Accent Flood and Spot Luminaires
Rated Voltage / Frequency	100 ~ 277 Vac, 50/60 Hz
Nominal Power	12W
Rated Initial Lamp Lumen	--
Declared CCT	5000K
LED Manufacturer	CREE
LED Model	CXA1507
Sample Receipt Date	Mar.28,2014
Sample Number	140307-5

Photo

Laboratory: Standard-Tech Co. Ltd Testing Center

NVLAP CODE: 201011-0

Report Format Number STD/QR4909-A/2

Address: 8th floor, Block B, No. 11 Caipin Road, Guangzhou Science City, Tianhe, Guangzhou 510663, China

Tel: 8620-3229 0320 Fax: 8620-32290422 <http://www.standard-tech.com>

2.1 Electrical, Photometric and Chromaticity Measurements (Refer to Work Instruction QD25)	IES LM-79 2008
--	-----------------------

Test date	2014-04-04	Test Ambient:	25.2 °C
Test Orientation	As intended	Stabilization Time (min)	90
Model Number	71363		

Electrical Measurement:

Sample No.	Voltage (Vac)	Frequency (Hz)	Current (A)	Power (W)	Power Factor	THD %
140307-5	120.1	60	0.0950	11.05	0.9683	13.70
	277.0	60	0.0455	11.67	0.9251	15.79

Sphere-Spectroradiometer Method:

Parameter	Result
Test Voltage (V)	120.0
Frequency (Hz)	60
Color Rendering Index (CRI)	75.1
R9	0
CCT (K)	5098
Chromaticity (x, y)	x=0.3424 y=0.3488
Chromaticity (u', v')	u'=0.2107 v'=0.4829
Duv	-0.0003

Special Color Rendering Indices			
R1	74	R9	0
R2	79	R10	49
R3	81	R11	73
R4	76	R12	46
R5	74	R13	74
R6	71	R14	89
R7	83	R15	70
R8	63	--	--

Goniophotometer Method:

Parameter	Result
Test Voltage (V)	120.1
Frequency (Hz)	60
Test Current (A)	0.0950
Power Factor	0.9683
Test Power (W)	11.05
Total Luminous (lm)	814.25
Luminous Efficacy (lm/W)	73.69
Beam Angle°	68.5
Center Beam Candle Power (cd)	672.4
S/MH(C0/180)	1.01
S/MH(C90/270)	1.04

Spectral Power Distribution

Spectral Power Distribution:

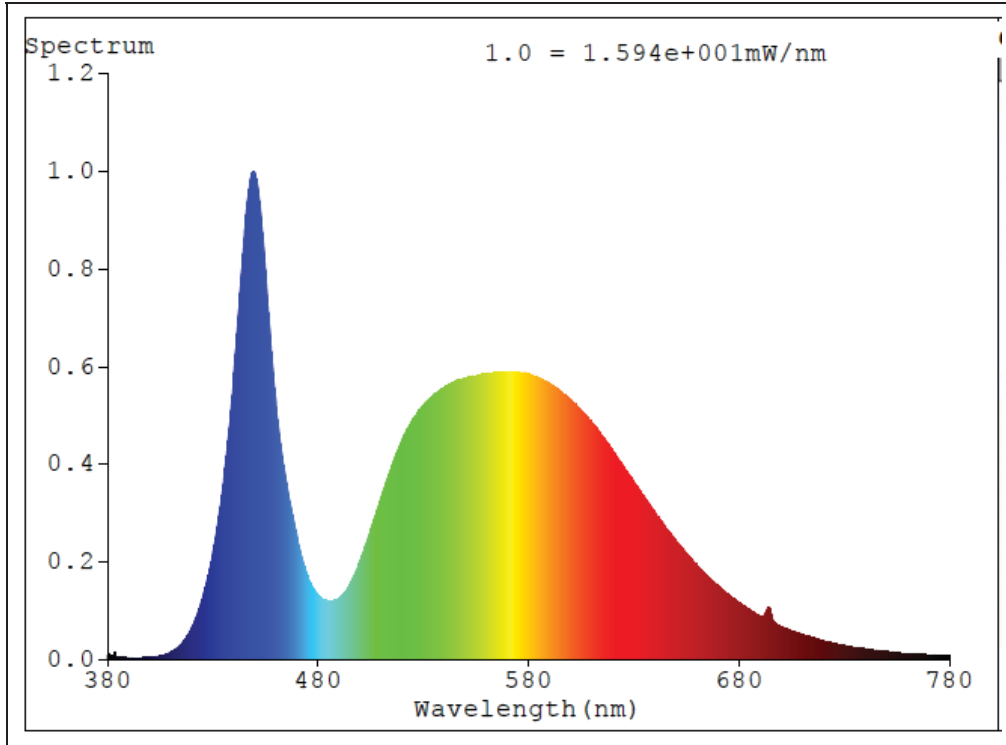

Laboratory: Standard-Tech Co. Ltd Testing Center
NVLAP CODE: 201011-0

Report Format Number STD/QR4909-A/2

Address: 8th floor, Block B, No. 11 Caipin Road, Guangzhou Science City, Tianhe, Guangzhou 510663, China

Tel: 8620-3229 0320 Fax: 8620-32290422 <http://www.standard-tech.com>

Chromaticity Diagram

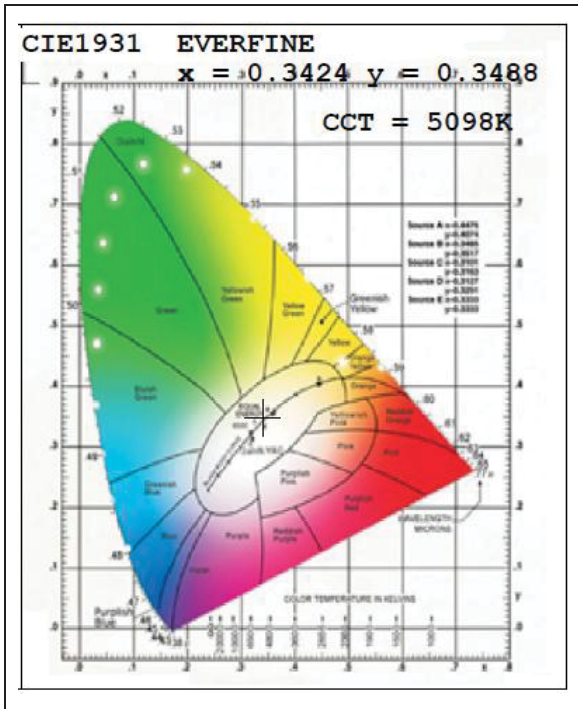

Laboratory: Standard-Tech Co. Ltd Testing Center
NVLAP CODE: 201011-0

Report Format Number STD/QR4909-A/2

Address: 8th floor, Block B, No. 11 Caipin Road, Guangzhou Science City, Tianhe, Guangzhou 510663, China

Tel: 8620-3229 0320 Fax: 8620-32290422 <http://www.standard-tech.com>

Zonal Lumen Tabulation

Zonal Lumen Summary			
Zone	Lumens	% Lamp	% Luminaire
0-30	489.0	60.1%	60.1%
0-40	695.9	85.5%	85.5%
0-60	810.3	99.5%	99.5%
60-90	3.8	0.5%	0.5%
70-100	1.2	0.2%	0.2%
90-120	0.0	0%	0%
0-90	814.0	100%	100%
90-180	0.1	0%	0%
0-180	814.1	100%	100%

Lumens Per Zone					
Zone	Lumens	% Total	Zone	Lumens	% Total
0-10	62.2	7.6%	90-100	0.0	0%
10-20	177.8	21.8%	100-110	0.0	0%
20-30	249.1	30.6%	110-120	0.0	0%
30-40	206.8	25.4%	120-130	0.0	0%
40-50	107.2	13.2%	130-140	0.0	0%
50-60	7.1	0.9%	140-150	0.0	0%
60-70	2.5	0.3%	150-160	0.0	0%
70-80	1.0	0.1%	160-170	0.0	0%
80-90	0.3	0.0%	170-180	0.0	0%

Laboratory: Standard-Tech Co. Ltd Testing Center
 NVLAP CODE: 201011-0

Report Format Number STD/QR4909-A/2

Address: 8th floor, Block B, No. 11 Caipin Road, Guangzhou Science City, Tianhe, Guangzhou 510663, China

Tel: 8620-3229 0320 Fax: 8620-32290422 <http://www.standard-tech.com>

Photometric Data

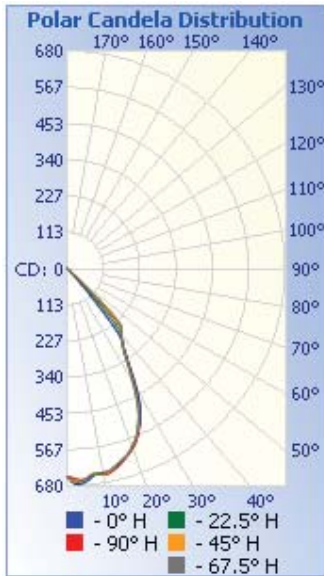

Illuminance Plots

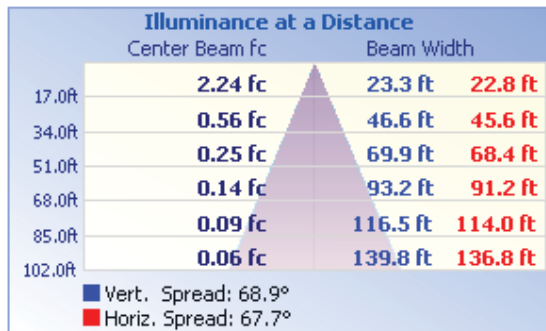

Laboratory: Standard-Tech Co. Ltd Testing Center
 NVLAP CODE: 201011-0

Report Format Number STD/QR4909-A/2

Address: 8th floor, Block B, No. 11 Caipin Road, Guangzhou Science City, Tianhe, Guangzhou 510663, China

Tel: 8620-3229 0320 Fax: 8620-32290422 <http://www.standard-tech.com>

ISOCANDELA DIAGRAM

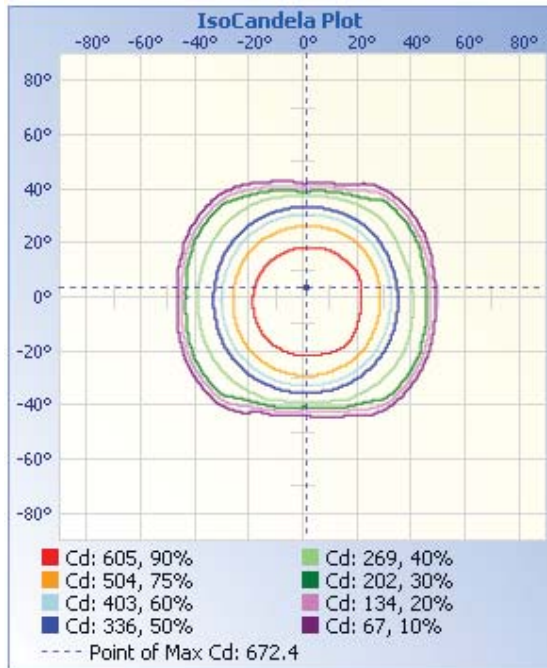

ISOLUX DIAGRAM

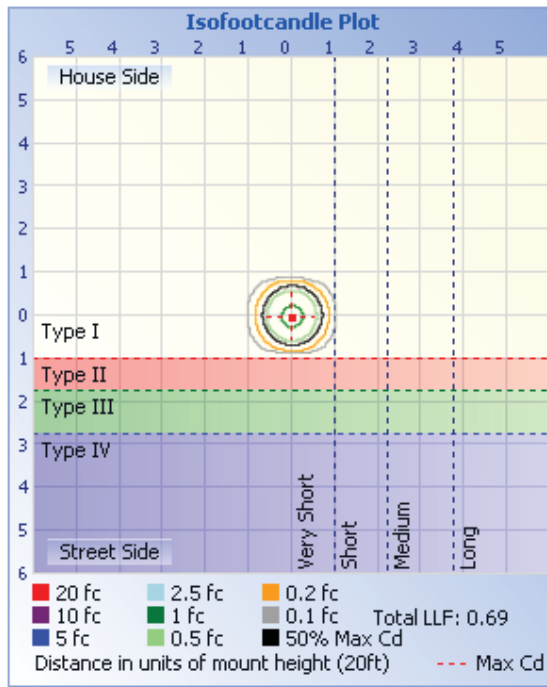

Laboratory: Standard-Tech Co. Ltd Testing Center
NVLAP CODE: 201011-0

Report Format Number STD/QR4909-A/2

Address: 8th floor, Block B, No. 11 Caipin Road, Guangzhou Science City, Tianhe, Guangzhou 510663, China

Tel: 8620-3229 0320 Fax: 8620-32290422 <http://www.standard-tech.com>

Candela Table - Type C

	0	22.5	45	67.5	90	112.5	135	157.5	180	202.5	225	247.5	270	292.5	315	337.5	360
0	647	647	647	647	647	647	647	647	647	647	647	647	647	647	647	647	647
1	661	660	658	654	650	645	641	639	638	638	641	645	649	653	657	660	661
2	670	668	664	661	654	648	642	637	636	636	640	647	654	660	666	670	670
3	672	669	666	663	658	652	644	638	637	637	642	651	659	666	670	672	672
4	670	666	662	661	659	656	648	640	639	641	644	655	662	668	671	672	670
5	666	659	656	656	656	656	650	644	643	645	646	654	660	666	668	667	666
6	659	650	648	650	650	651	649	646	648	650	649	654	657	662	662	661	659
7	651	644	644	646	646	647	646	645	651	654	651	654	655	657	654	652	651
8	645	642	644	646	645	646	645	644	653	656	653	653	652	650	648	646	645
9	644	644	647	649	647	647	646	644	652	656	655	654	651	648	645	645	644
10	644	646	649	649	651	647	646	644	651	653	654	653	653	647	644	645	644
11	645	647	649	646	652	645	644	643	648	649	652	654	654	646	644	645	645
12	644	644	644	640	649	640	641	640	642	643	647	648	653	645	642	644	644
13	640	639	639	634	643	635	637	635	634	636	640	641	651	643	642	642	640
14	635	632	632	628	638	631	633	629	628	631	635	632	647	642	639	638	635
15	629	624	625	624	632	629	629	623	622	628	630	626	642	639	633	631	629
16	622	617	619	620	624	627	627	621	618	625	629	623	636	634	626	625	622
17	616	612	613	615	618	622	624	620	618	622	628	622	628	631	620	620	616
18	609	606	606	609	610	614	620	618	618	620	628	620	624	628	618	616	609
19	600	598	599	601	603	608	612	616	616	617	627	618	622	625	614	611	600
20	591	589	590	591	596	601	606	610	613	614	626	615	617	621	608	602	591
21	582	580	581	580	587	595	601	604	608	611	624	611	610	615	600	593	582
22	572	569	571	569	576	586	593	596	601	606	617	603	599	604	591	581	572
23	561	556	560	557	563	576	584	588	592	598	608	595	588	591	579	569	561
24	548	540	545	542	547	563	573	581	583	588	598	585	577	576	566	557	548
25	533	524	527	524	529	545	558	570	573	577	582	571	564	561	552	542	533
26	516	508	507	505	510	523	538	554	560	563	565	553	548	547	536	527	516
27	499	490	487	482	490	500	518	534	543	545	546	536	532	530	521	510	499
28	480	470	463	458	467	476	495	512	522	526	527	517	513	510	503	492	480
29	457	445	437	433	441	450	469	488	500	503	504	495	490	487	481	471	457

Laboratory: Standard-Tech Co. Ltd Testing Center

NVLAP CODE: 201011-0

Report Format Number STD/QR4909-A/2

Address: 8th floor, Block B, No. 11 Caipin Road, Guangzhou Science City, Tianhe, Guangzhou 510663, China

Tel: 8620-3229 0320 Fax: 8620-32290422 <http://www.standard-tech.com>

30	431	418	412	406	415	423	442	461	473	478	479	472	465	461	456	445	431
31	403	391	385	381	388	397	414	432	445	451	452	443	438	432	427	415	403
32	375	365	361	358	363	372	387	403	417	423	423	414	409	400	397	384	375
33	350	342	338	337	340	348	360	375	389	394	392	385	379	369	368	357	350
34	329	322	319	319	321	328	336	349	361	365	363	358	353	341	344	333	329
35	311	306	304	304	305	311	316	326	337	340	337	336	330	319	324	314	311
36	297	294	293	291	293	297	301	308	316	319	317	318	313	301	308	300	297
37	286	285	283	282	284	287	290	294	301	303	302	303	299	287	294	289	286
38	266	276	275	275	276	279	280	284	288	291	290	291	287	277	284	280	266
39	224	269	268	268	269	272	272	275	262	281	281	283	278	270	276	271	224
40	170	261	262	263	263	267	265	266	209	273	274	276	271	264	269	252	170
41	112	232	257	258	258	261	260	239	157	264	268	270	265	260	263	212	112
42	62	189	252	254	253	255	255	189	104	238	264	265	259	256	259	160	62
43	39	136	246	249	238	249	248	138	54	187	259	260	254	253	253	105	39
44	17	84	230	234	191	242	241	87	24	137	255	255	247	248	247	56	17
45	15	60	189	195	144	219	230	45	17	87	250	250	219	241	230	36	15
46	13	38	135	142	97	170	183	20	19	45	239	236	176	208	188	16	13
47	11	15	80	86	48	120	136	17	18	20	190	186	125	159	135	14	11
48	10	13	57	62	19	71	89	14	16	17	141	136	73	104	81	12	10
49	9	11	36	38	16	30	43	11	14	14	92	86	54	75	58	10	9
50	9	9	14	15	13	16	19	10	11	11	44	40	35	46	36	9	9
51	8	8	12	14	11	14	15	9	9	9	18	18	17	16	14	8	8
52	7	8	8	9	9	11	12	8	8	9	15	15	15	15	13	8	7
53	7	7	8	8	8	8	9	8	8	8	12	12	9	11	9	7	7
54	6	7	7	7	7	8	8	7	7	7	9	9	8	9	8	7	6
55	6	6	6	7	7	7	7	6	6	7	8	8	8	8	7	6	6
56	5	5	6	6	6	6	6	6	6	6	7	7	7	7	7	6	5
57	5	5	5	6	6	6	6	5	5	6	7	7	7	7	6	5	5
58	4	4	5	5	5	5	5	5	5	5	6	6	6	6	5	5	4
59	4	4	4	5	5	5	5	4	4	5	5	6	6	6	5	4	4
60	4	4	4	4	4	4	4	4	4	4	5	5	5	5	4	4	4
61	3	3	3	4	4	4	4	4	4	4	4	5	4	4	4	3	3

Laboratory: Standard-Tech Co. Ltd Testing Center

NVLAP CODE: 201011-0

Report Format Number STD/QR4909-A/2

Address: 8th floor, Block B, No. 11 Caipin Road, Guangzhou Science City, Tianhe, Guangzhou 510663, China

Tel: 8620-3229 0320 Fax: 8620-32290422 <http://www.standard-tech.com>

62	3	3	3	3	3	3	3	3	3	3	3	4	4	4	4	4	3	3
63	3	3	3	3	3	3	3	3	3	3	3	4	4	4	4	3	3	3
64	2	2	2	3	3	3	3	3	3	3	3	3	3	3	3	3	2	2
65	2	2	2	2	2	2	2	2	2	2	3	3	3	3	3	2	2	2
66	2	2	2	2	2	2	2	2	2	2	2	3	2	2	2	2	2	2
67	2	2	2	2	2	2	2	2	2	2	2	2	2	2	2	2	2	2
68	2	2	2	2	2	2	2	2	2	2	2	2	2	2	2	2	2	2
69	2	1	1	1	1	2	2	2	2	2	2	2	2	2	2	2	2	2
70	1	1	1	1	1	1	1	1	1	1	2	2	2	2	2	2	2	1
71	1	1	1	1	1	1	1	1	1	1	1	1	1	1	1	1	1	1
72	1	1	1	1	1	1	1	1	1	1	1	1	1	1	1	1	1	1
73	1	1	1	1	1	1	1	1	1	1	1	1	1	1	1	1	1	1
74	1	1	1	1	1	1	1	1	1	1	1	1	1	1	1	1	1	1
75	1	1	1	1	1	1	1	1	1	1	1	1	1	1	1	1	1	1
76	1	1	1	1	1	1	1	1	1	1	1	1	1	1	1	1	1	1
77	1	1	1	1	1	1	1	1	1	1	1	1	1	1	1	1	1	1
78	1	1	1	1	1	1	1	1	1	1	1	1	1	1	1	1	1	1
79	1	1	0	0	0	0	0	1	1	1	1	1	1	1	1	1	1	1
80	1	0	0	0	0	0	0	0	1	0	0	0	0	0	0	0	1	1
81	1	0	0	0	0	0	0	0	0	0	0	0	0	0	0	0	1	1
82	1	0	0	0	0	0	0	0	0	0	0	0	0	0	0	0	0	1
83	1	0	0	0	0	0	0	0	0	0	0	0	0	0	0	0	0	1
84	1	0	0	0	0	0	0	0	0	0	0	0	0	0	0	0	0	1
85	0	0	0	0	0	0	0	0	0	0	0	0	0	0	0	0	0	0
86	0	0	0	0	0	0	0	0	0	0	0	0	0	0	0	0	0	0
87	0	0	0	0	0	0	0	0	0	0	0	0	0	0	0	0	0	0
88	0	0	0	0	0	0	0	0	0	0	0	0	0	0	0	0	0	0
89	0	0	0	0	0	0	0	0	0	0	0	0	0	0	0	0	0	0
90	0	0	0	0	0	0	0	0	0	0	0	0	0	0	0	0	0	0

Laboratory: Standard-Tech Co. Ltd Testing Center

NVLAP CODE: 201011-0

Report Format Number STD/QR4909-A/2

Address: 8th floor, Block B, No. 11 Caipin Road, Guangzhou Science City, Tianhe, Guangzhou 510663, China

Tel: 8620-3229 0320 Fax: 8620-32290422 <http://www.standard-tech.com>

3. Test Equipment

Equipment ID	Equipment Name	Last Calibration Date	Next Calibration Date
ST-R-336	2 meter Integrating Sphere	2013-07-08	2014-07-07
ST-R-331	Spectral analysis system HAAS-2000	2013-06-21	2014-06-20
D204	Standard Lamp	2013-06-28	2014-06-27
PF2010	Power Meter for Integrating Sphere	2013-06-20	2014-06-19
EE-09	Goniophotometer system	2013-06-21	2014-06-20
D908S	Standard Lamp	2013-07-05	2014-07-04
PF210	Power Meter for Goniophotometer	2013-06-20	2014-06-19
ST-R-181A	Temperature Tester	2013-08-14	2014-08-13

******* END OF DATASHEET PACKAGE *******